

Инструкция по установке
Grossman GR-4130L/R

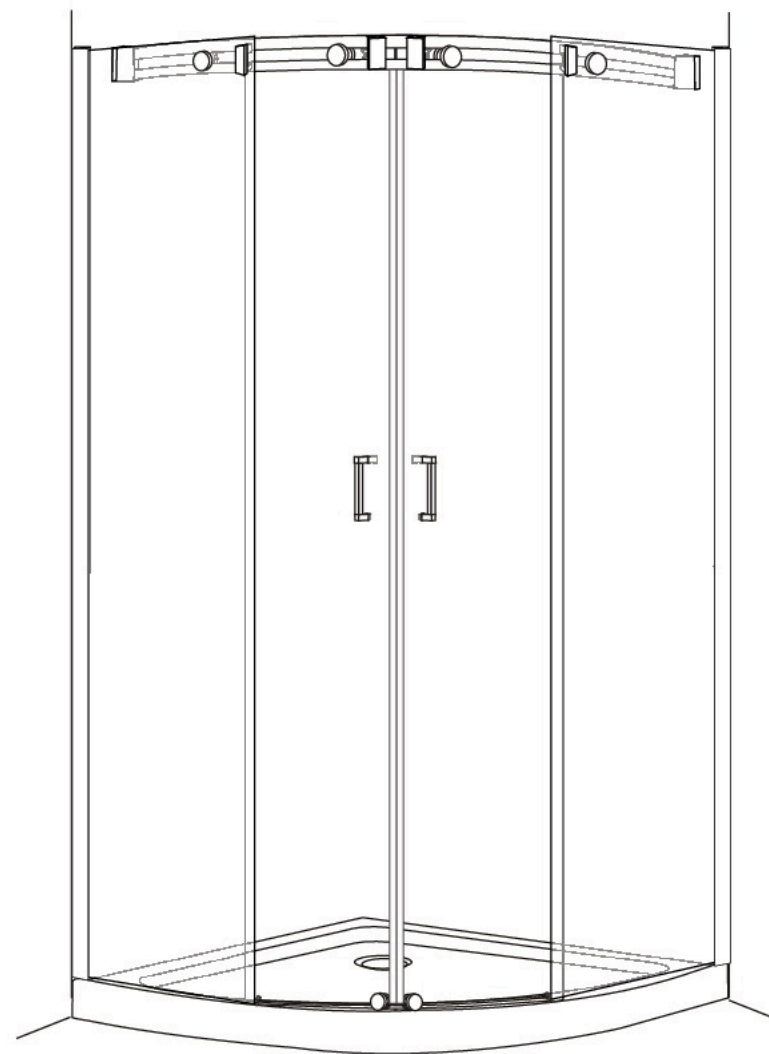

Grossman.su
продажа, установка
8(495)972-80-69







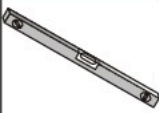

Important Reminder

1. Please install the shower enclosure according to the instruction strictly, otherwise, it will affect the operational performance.
2. After opening the carton, please check the parts according to the part list.
3. Please handle the glass parts carefully, don't knock on the glass to avoid damage.
4. After installation completely, please use it after 24 hours.

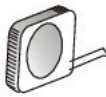



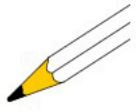





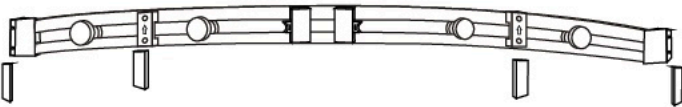



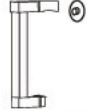

Notice

1. Do not let children, old people or disabled people enter the room alone.
2. Do not climb or hang heavy things on the shower enclosure.
3. Do not knock and impact the glass with heavy things.
4. Caution slippery on the inside of the shower enclosure.
5. Ordinary liquid detergent should be used with a soft cloth for cleaning.
6. Apply silicone to prevent water leakage.
7. Keep the tray clean, avoid hair and sundries to jam the drain.

Tools:

			
Spirit Level	5.5mm drill	Tape measure	Cross screw driver
			
Scissors	Silicone Gun	Pencil	Rubber mallet

Part list

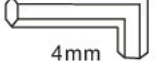
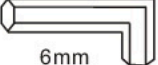
A 		
B  Screws ST4X25 X8	C  ST4X25 Flathead screws X2	D  Screws ST4X10 X8
E  Wall plug X10	F  Glass Clip X2	G  Bottom Roller X2
H  Handle X2	I  Wall Profile X2	J  Fixed Glass Panels X2
K  Sliding Door X2	L  Rubber Seal X4	M  Magnetic Seal X2
N  Bottom Rail	O  Shower Tray(Available Separately)	P  Drill bit 3mm
R  ST4X40 Flathead screws X2	S  Screw cover cap X2	T  4mm Allen Key
U  6mm Allen Key X2		

Installation Procedure

STEP1:

Tray assembling

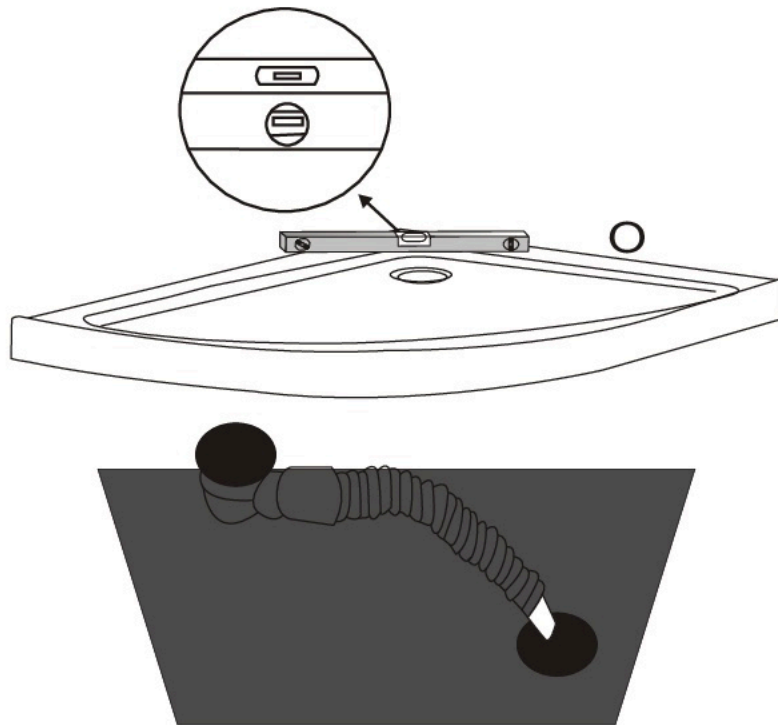

Connect the waste pipe of shower tray to the waste pipe in the floor.

- Fit the shower tray(available separately) in the required position.
- If the shower enclosure is not being installed on a shower tray, please choose a suitable flooring type to fit the enclosure to.

STEP2:

Wall profiles assembling

A:SIZE:100×100×195cm

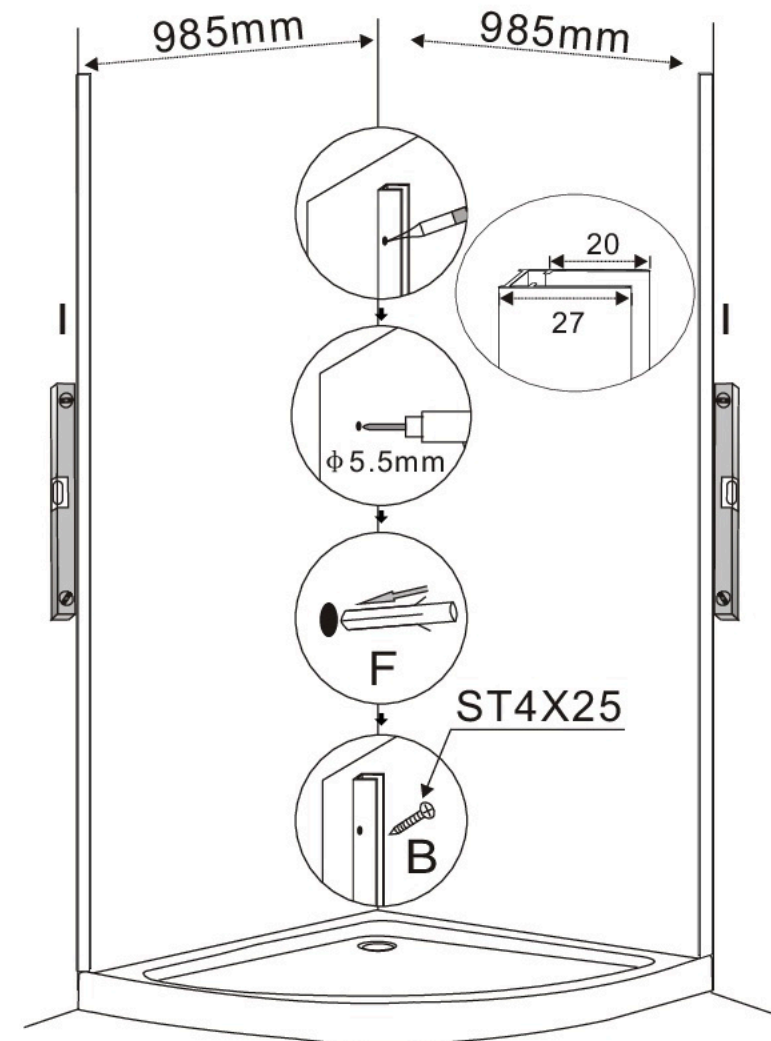

STEP2:
Wall profiles assembling
B:SIZE:90×90×195cm

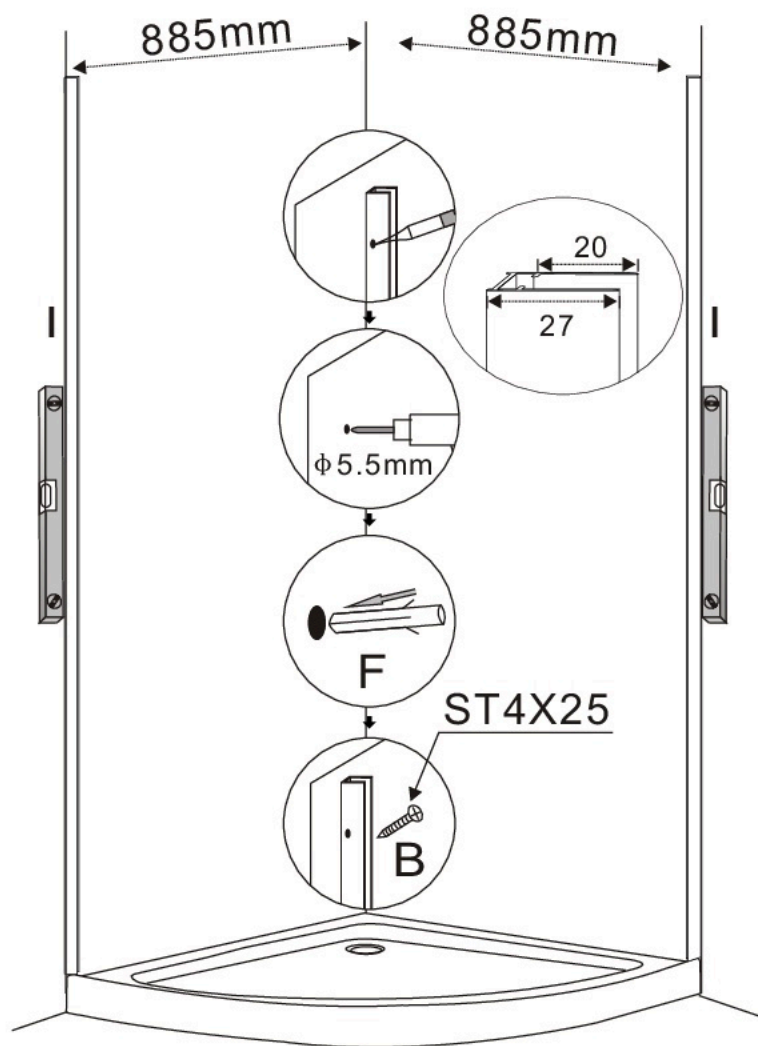

STEP2:
Wall profiles assembling
C:SIZE:80×80×195cm

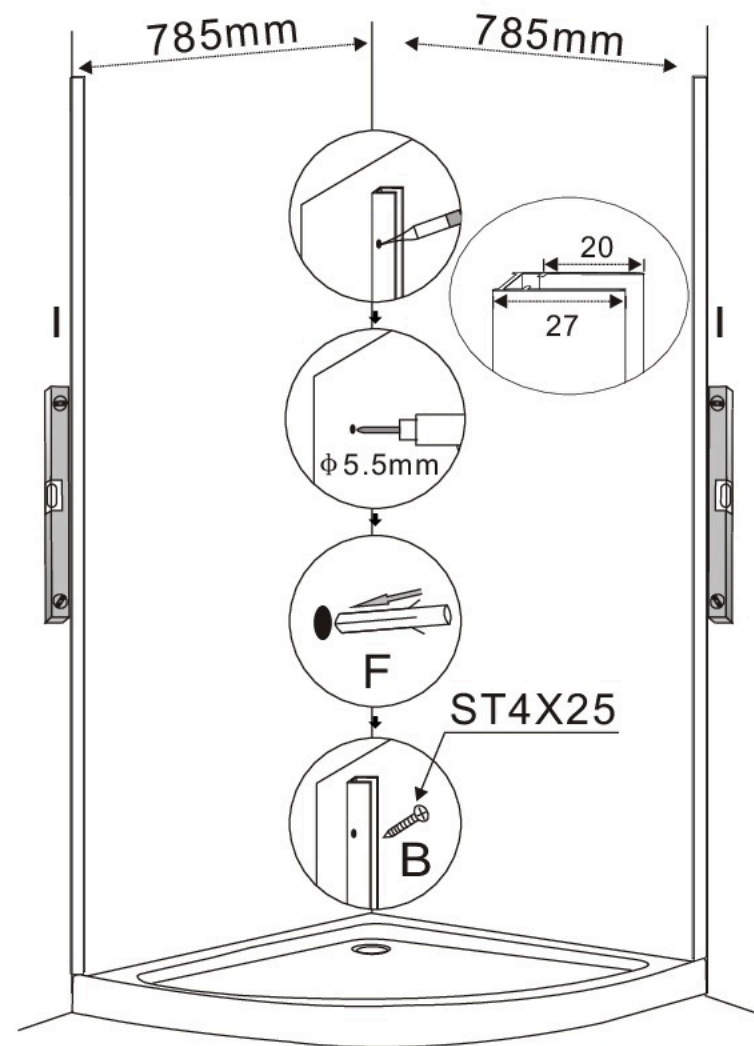

-Measure the correct distance from the corner to the required positions of the outside of the wall profiles and mark this position on the wall with a pencil.

-Position the wall profiles against these marks and use a spirit level to ensure they are vertical.

-Using the wall profiles as a template, mark the positions of the pre-drilled holes on the wall.

-Drill the positions marked using a 5.5mm drill bit.

-Use a rubber mallet to insert the wall plugs into the holes.

-Fix the wall profiles with screws 4x25mm [B] .

STEP3: Fixed glass panels Assembling

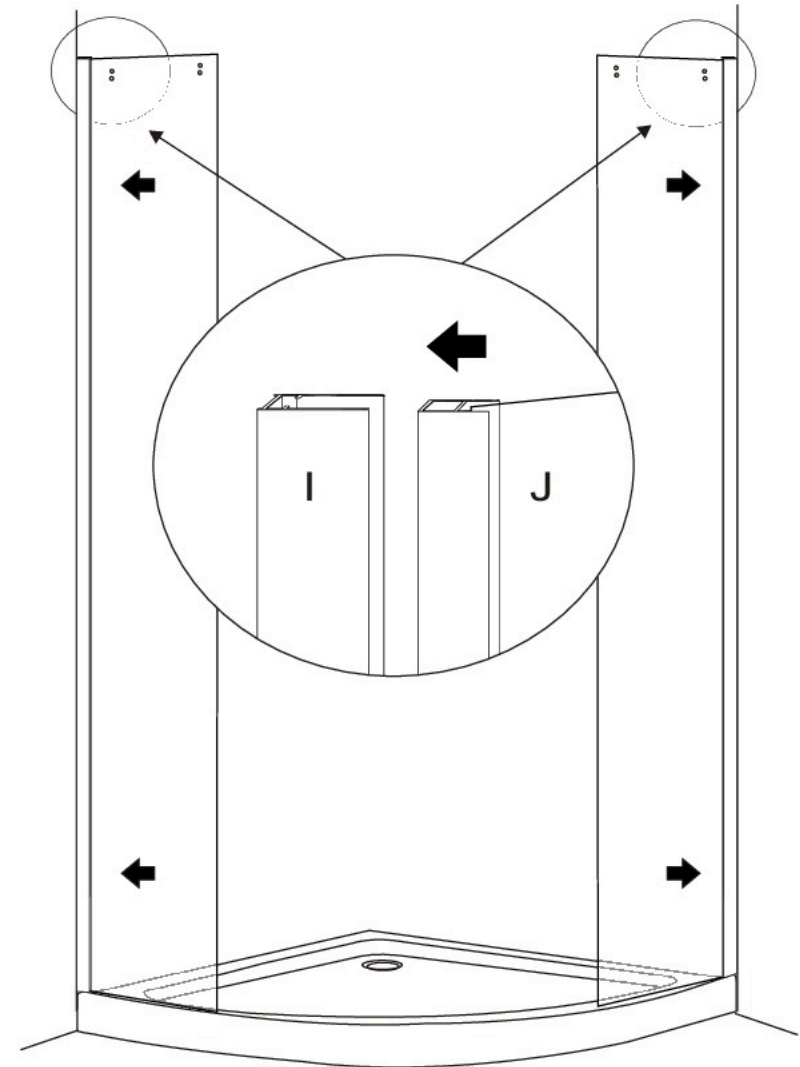

-Insert the fixed glass panels into the wall profiles.
(Note: please make sure the two glass panels are vertical with each other.)

STEP4: Fixed glass panels Assembling

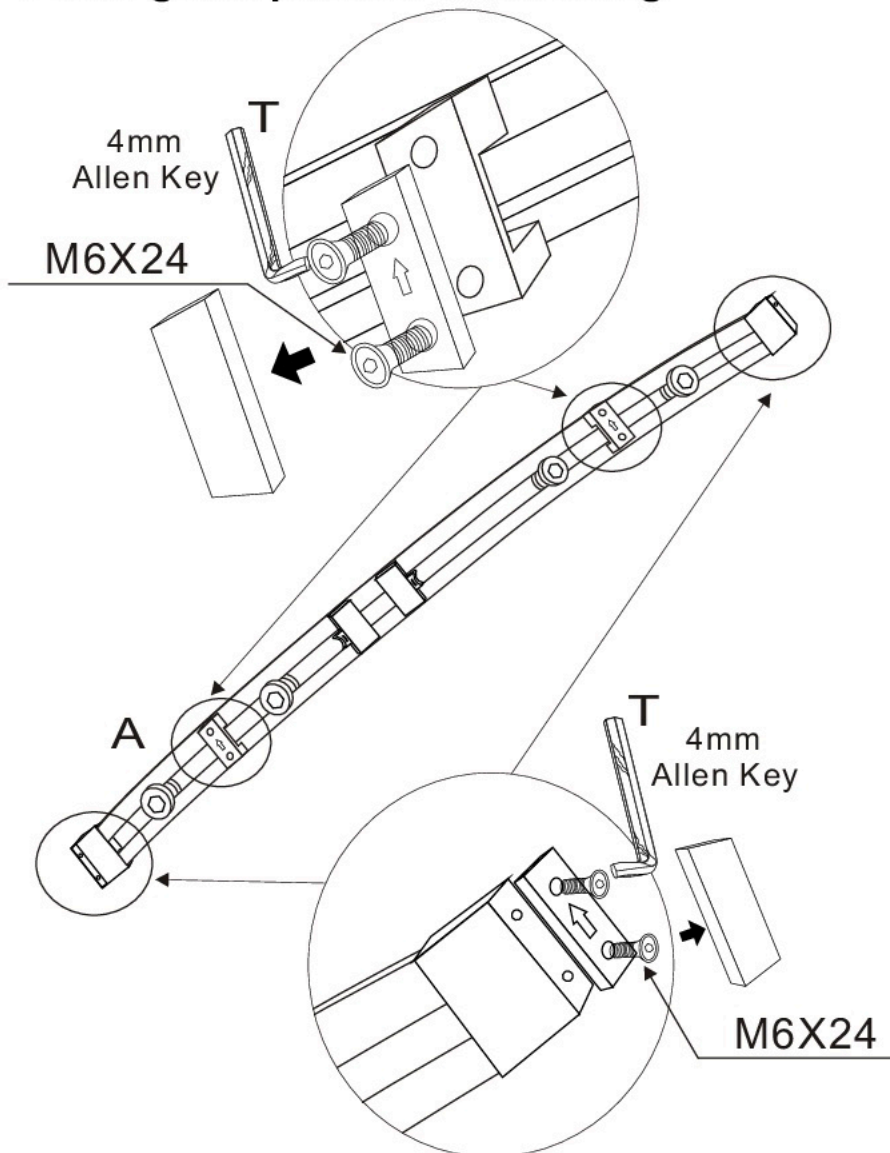

-Loose the pre-fixed screw 6x24mm and dis-assembled the pre-fixed plastic connectors on the top rails.

STEP5: Fixed glass panels Assembling

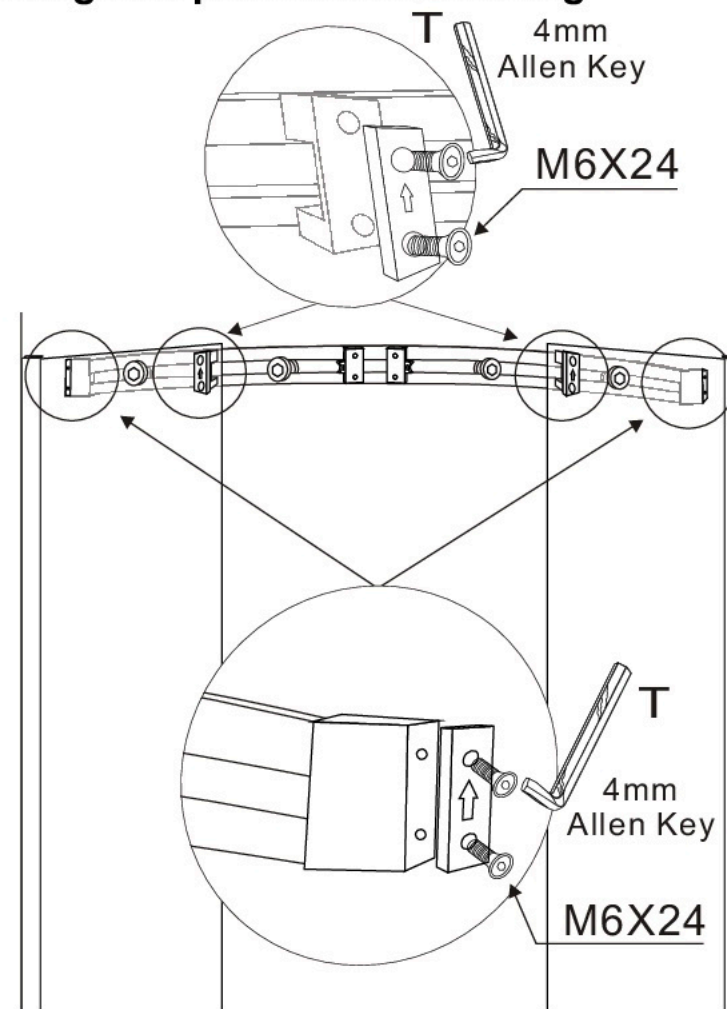

-Place the top rails in correct positions from the inside of glass panels, and make sure the holes on the fixed glass panels be overlapped with the holes on the plastic connectors of top rails.
-Using the screw 6x24mm to connect the fixed glass panels to the top rails.

STEP6:

Bottom Rails Assembling

Option 1: The shower enclosure is installed on the shower tray.

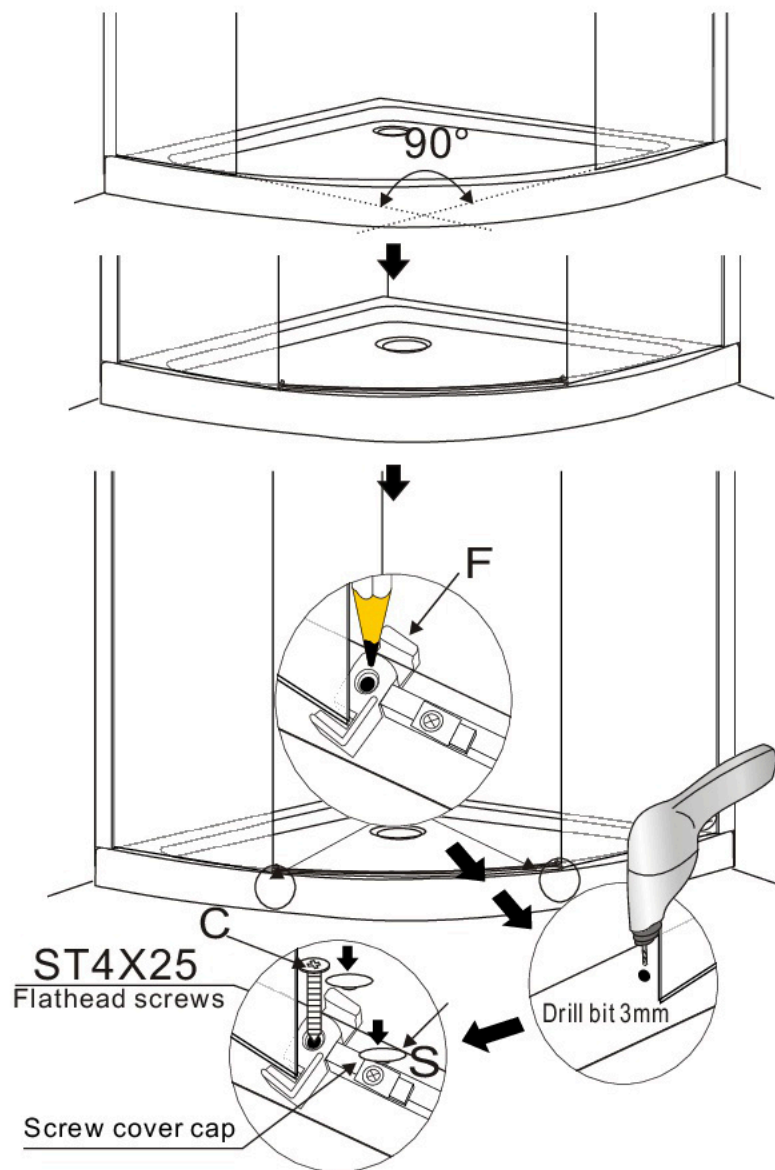

STEP6:

Bottom Rails Assembling

Option 2: The shower enclosure is installed on the floor.

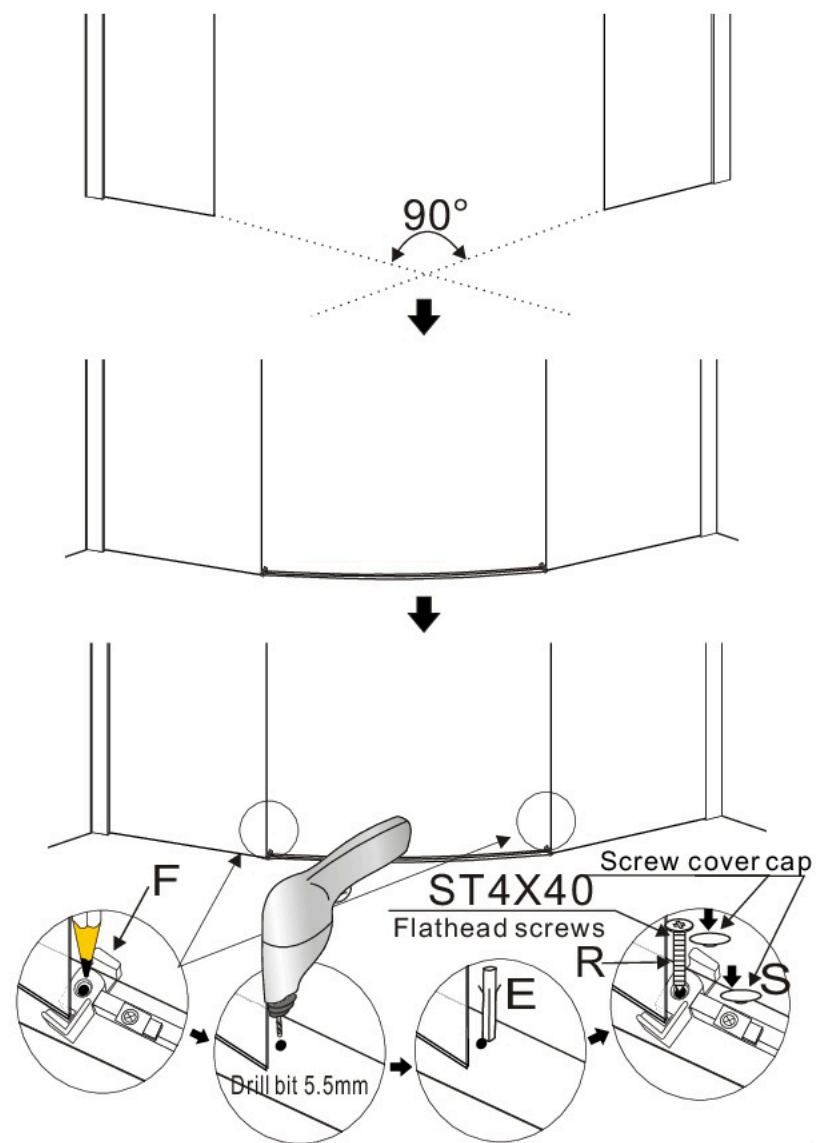

- Insert the glass clips [F] onto the fixed glass panels.
- Insert the bottom rails into the glass clips [F] .
- Make sure the glass clips and the bottom rails be in level with the edge of shower tray.
- Use a pencil to mark the positions of the pre-drilled holes on the shower tray.
- Remove the glass clips, bottom rails, and drill the marked positions with a 3mm drill bit.
- (Note: If the shower enclosure is not installed on the shower tray, but on the floor, a 5.5mm drill bit should be used.)
- Put the glass clips, bottom rails back to the position, and line up the holes with the holes drilled. Fix them with flathead screw 4x25mm [C] . Put the screw cover caps on.
- (Note: If the shower enclosure is not installed on the shower tray, but on the floor, the wall plugs should be used before fixing the flathead screws 4x40mm [R])

STEP7: Sliding Doors Assembling

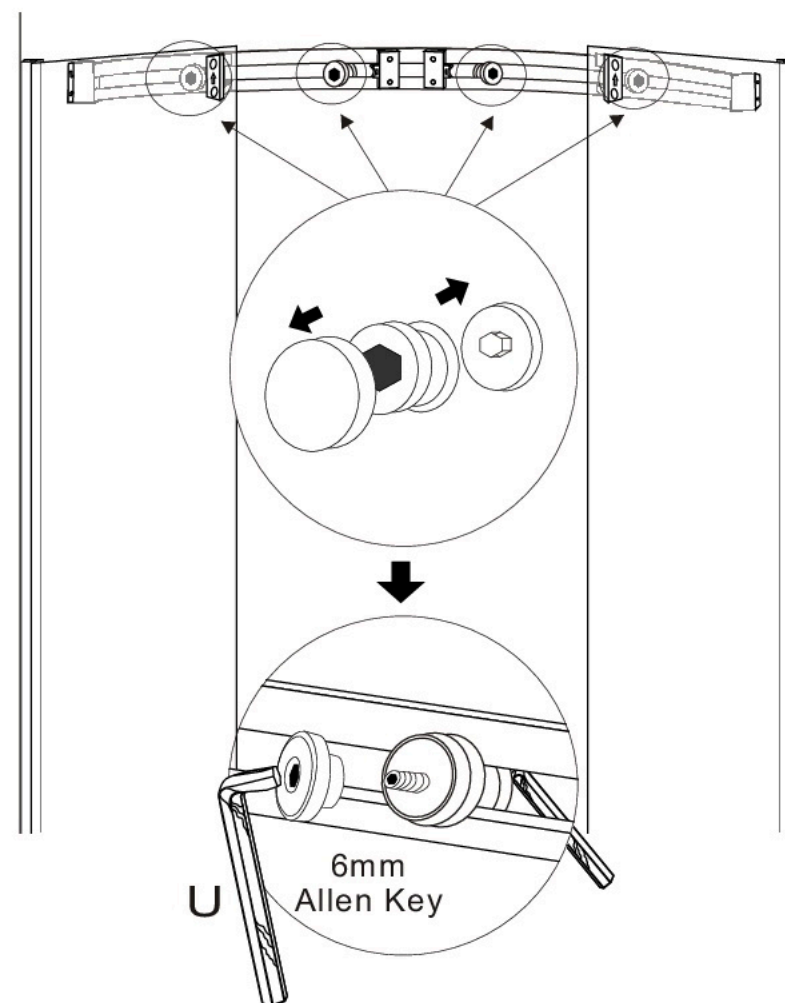

- Remove the the caps of top rollers. Disassemble the top rollers with 6mm allen keys.

STEP8: Sliding Doors Assembling

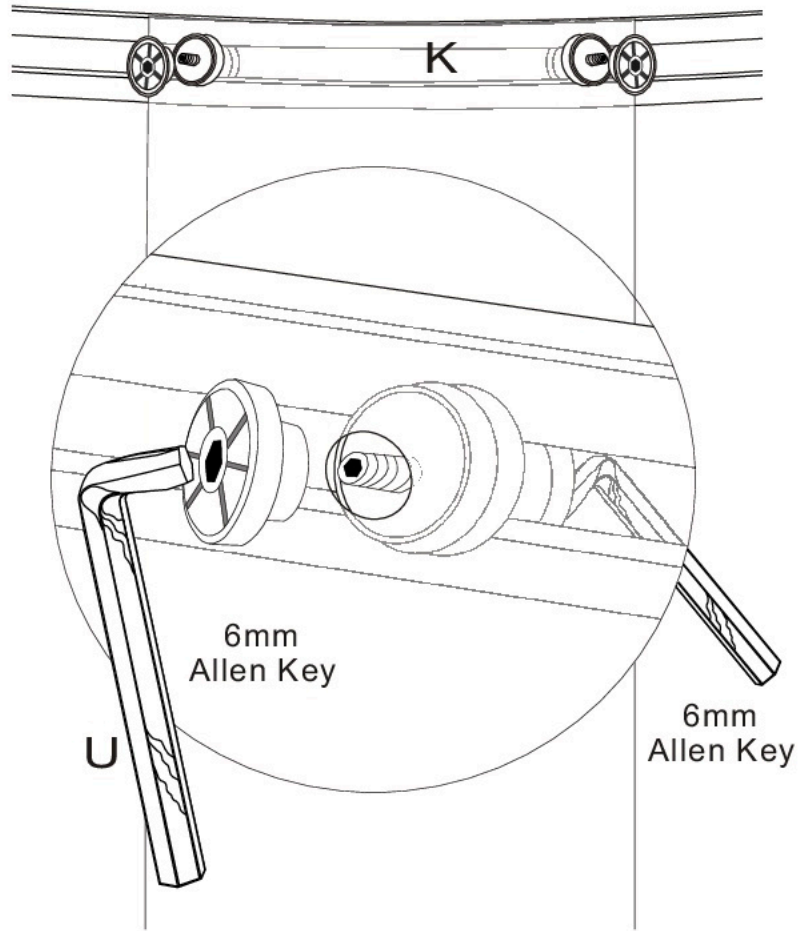

-Insert the top rollers into the holes on the sliding doors through the top rails. Then, fix the top rollers with 6mm allen keys.
(Note: please do not screw the rollers too tight to allow for adjustment if required.)

STEP9: Sliding Doors Assembling

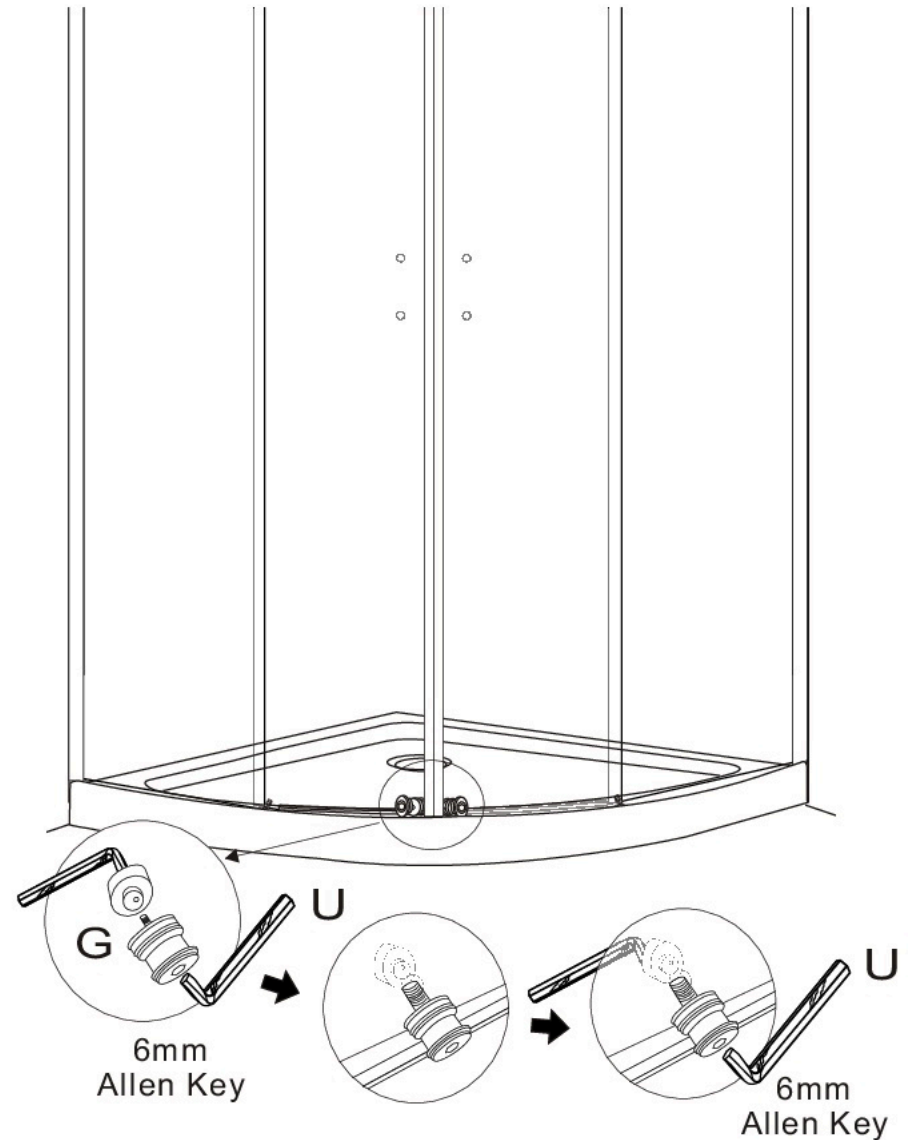

-Disassemble the bottom rollers with 6mm allen keys.

- Place the bottom rollers on the bottom rails. Insert the bottom rollers into the holes on the sliding doors.
- Fix the bottom rollers with 6mm allen keys. (Note: please do not screw the rollers too tight to allow for adjustment if required.)

STEP10: Magnetic Seals Assembling

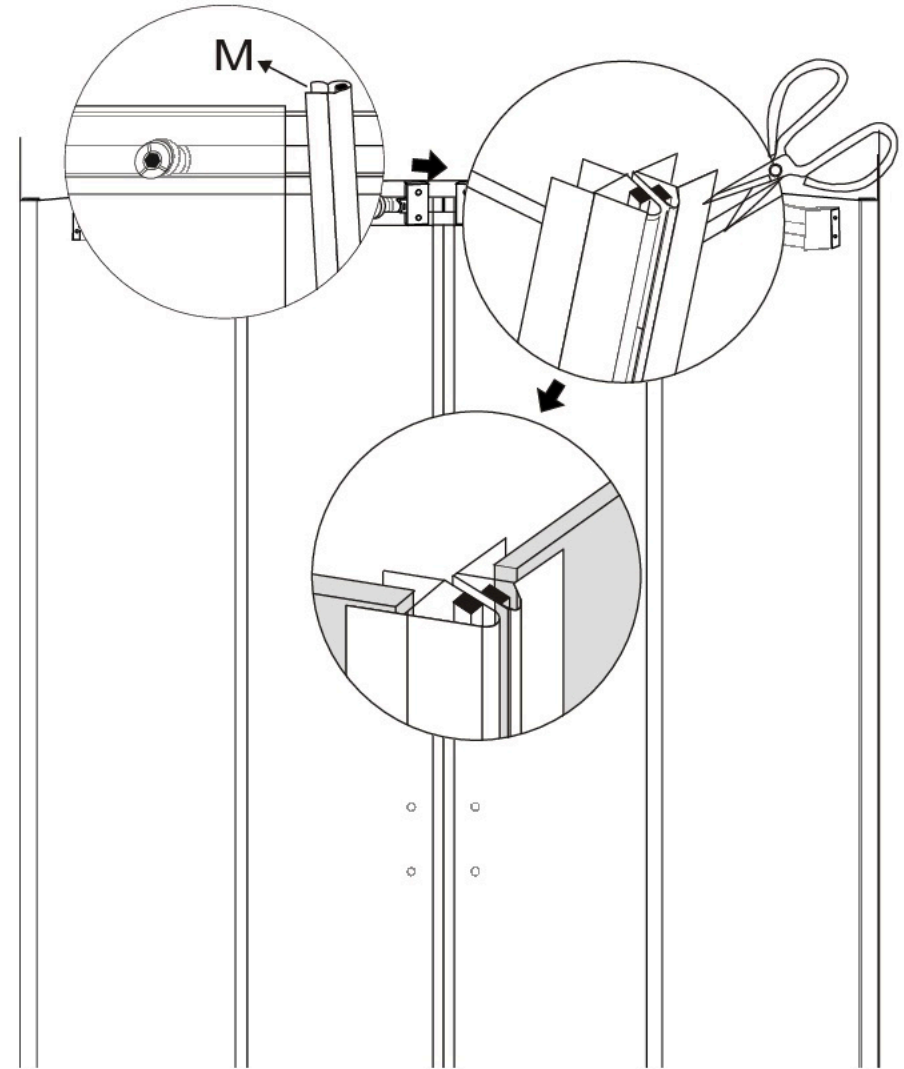

- Push the magnetic seals [M] onto the sliding doors. Cut into required length.

STEP11: Sliding Doors Adjustment

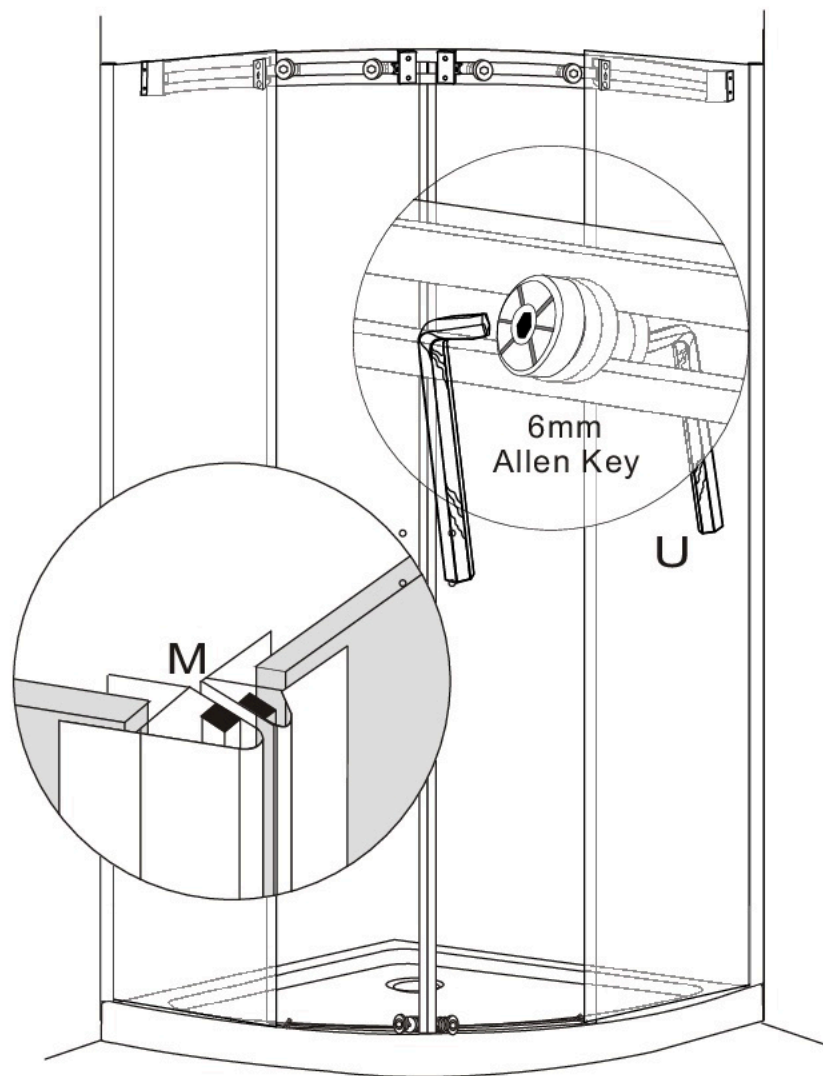

-Use 6mm allen keys to adjust the top and bottom rollers, to make sure the magnetic seals [M] be matched smoothly, also make sure the sliding doors can slide fluently.

STEP12: Rubber Seals and Handles Assembling

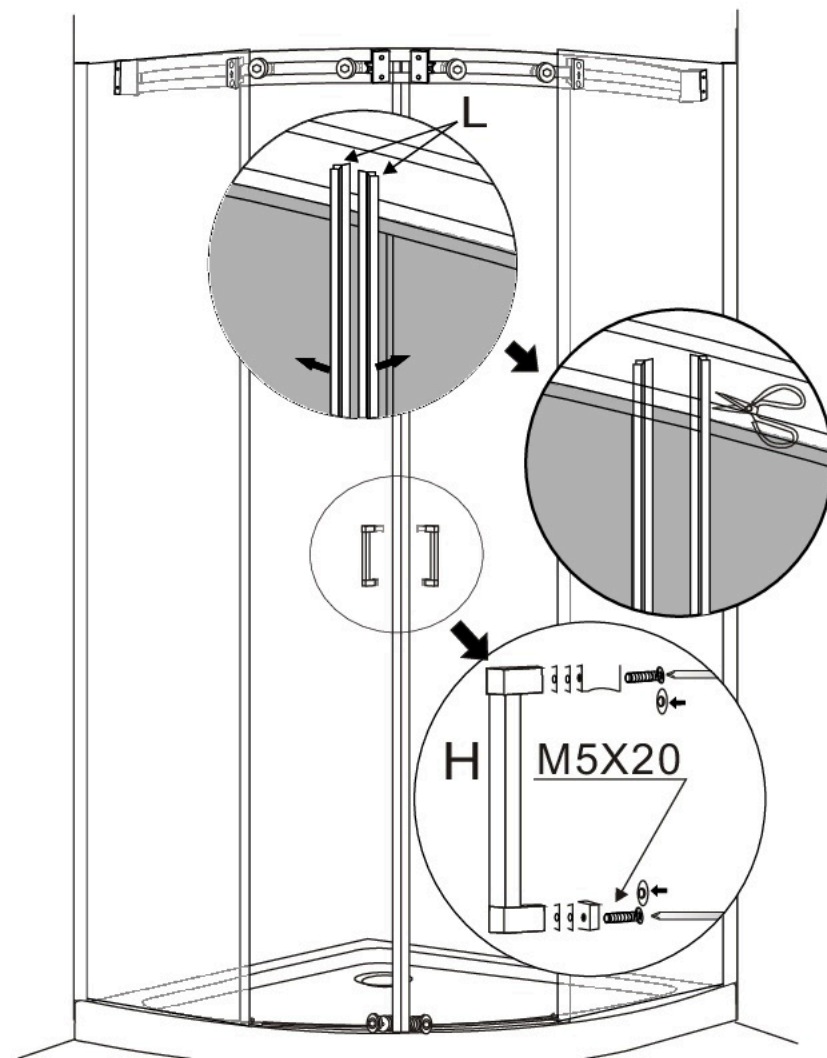

-Push the rubber seals [L] onto the fixed glass panels and sliding doors. Cut into required length.
-Use the cross screw driver to assemble the handles.

STEP13: Cover Caps Assembling

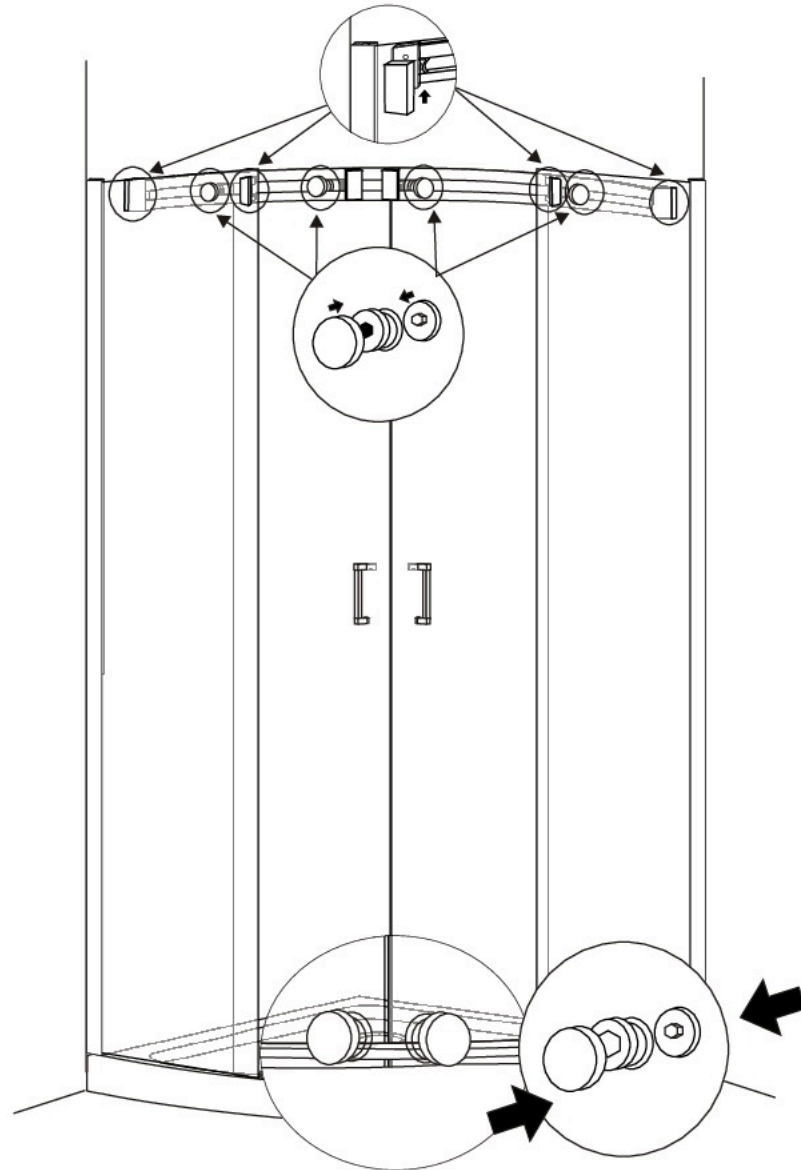

-Put the cover caps for the rails and rollers on.

STEP14: Fixing Wall Profiles

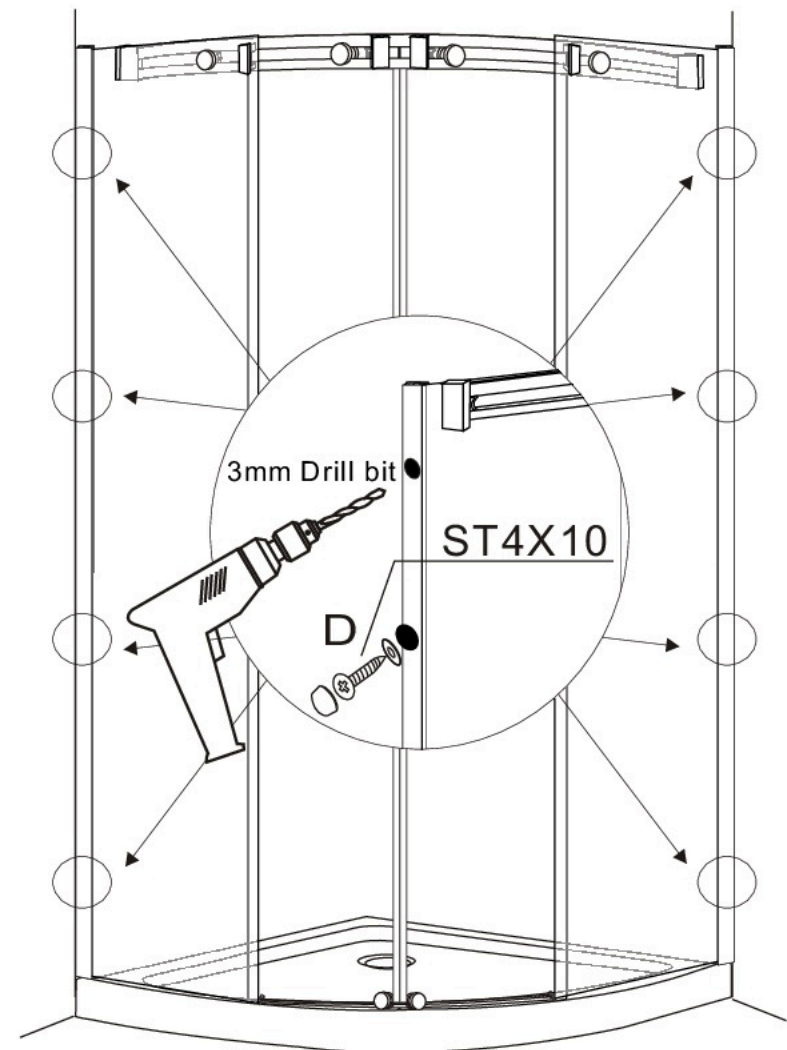

- Drill holes with 3mm bit on wall profile. (Note: Do not drill through the profiles, otherwise, it will damage the profile's surface.)
- Fix it with screw washer and screw 4x10mm 「D」 . Put the screw covers on.

STEP 15: Silicone Application

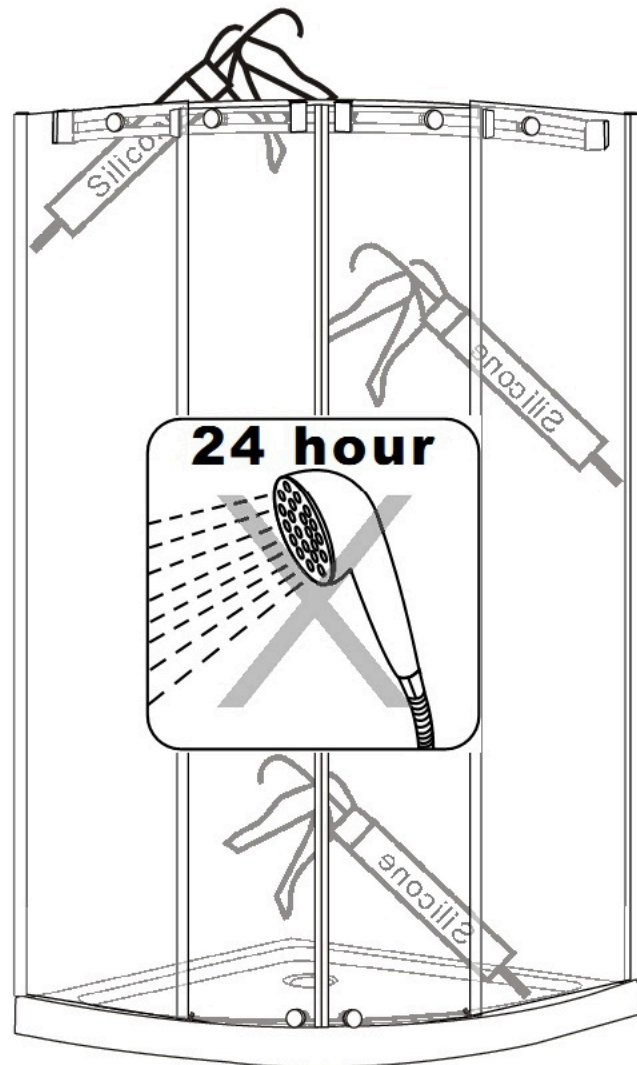

- Apply silicone sealant to all joints between wall profiles and tray.
- Do not use the enclosure for 24hours, to allow the silicone to dry completely.